

Panasonic Part AM-2PI

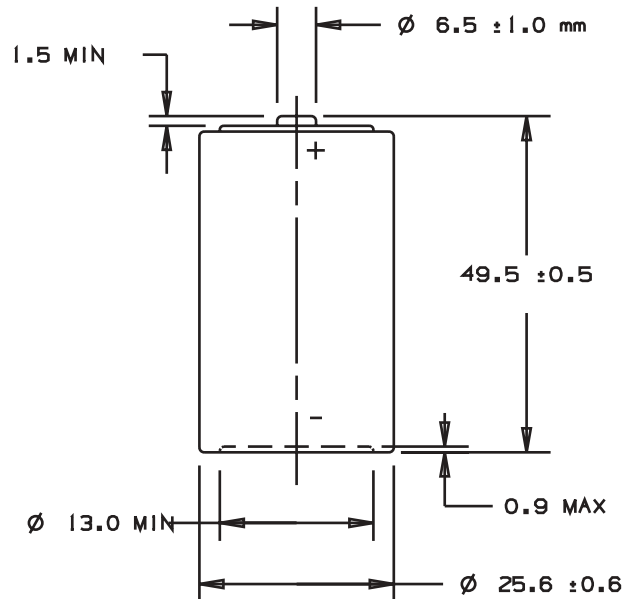

MADE IN THE USA

Dimensions Comply with ANSI Standards
mm



Chemical System:	Alkaline-Zinc/Manganese Dioxide (Zn/MnO ₂)
Designation:	ANSI-14A, IEC-LR14
Nominal Voltage:	1.5V
Internal Resistance:	0.10 Ohms
Temperature Range:	-20°C to 54°C (-4°F to 130°F)
Average Weight:	70 grams (2.47 oz.)
Volume:	26.9 cm ³ (1.6 in. ³)
Terminals:	Flat (Recessed Negative)
Shelf Life:	7 years (80% Capacity)
Heavy Metals Content:	No added Mercury, Cadmium or Lead

IEC/ANSI Standard Tests @ 20°C

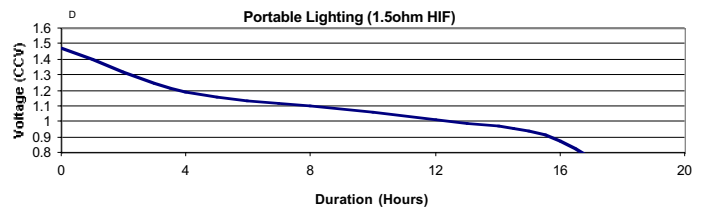
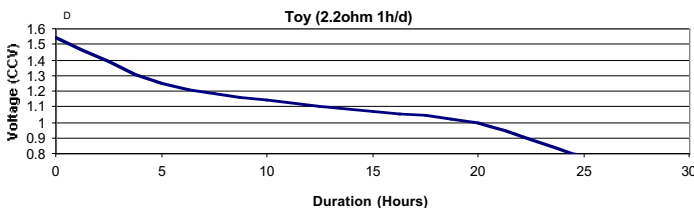
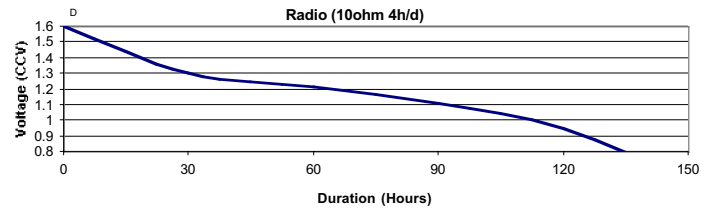
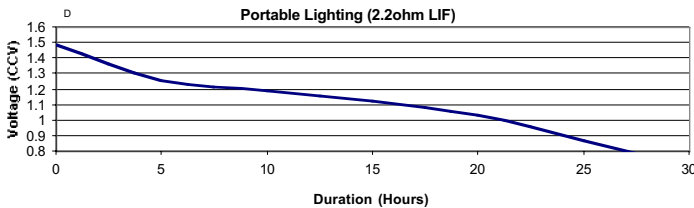

C

Typical Discharge Characteristics With Constant Current At 20°C

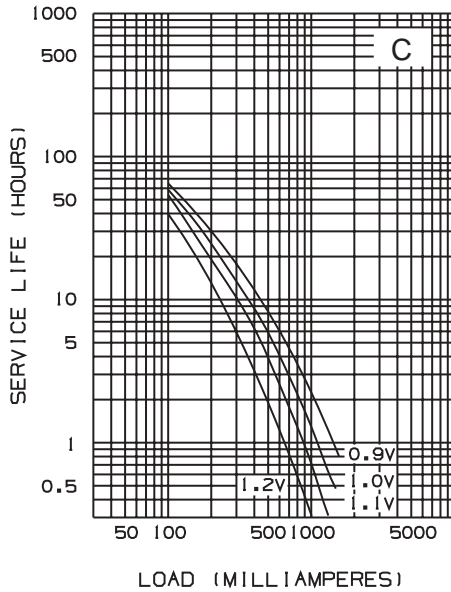

Typical Discharge Characteristics With Constant Resistance At 20°C

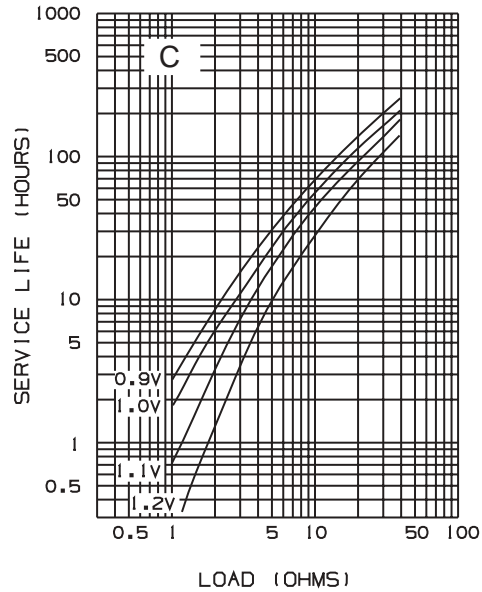

Typical Temperature Characteristics
0.9 Volts Cutoff Voltage

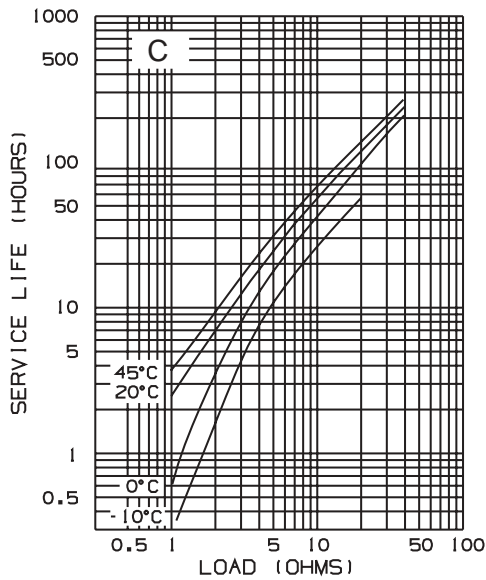

This information is generally typical and is not intended to make or imply any representation, guarantee or warranty with respect to any cells and batteries. Cell and battery designs/specifications are subject to modification without notice. Cell/battery performance and service life depends on the operating temperature, cut-off voltage and load applied to cell/battery in a specific application. It is the responsibility of each user to ensure that each cell/battery application is adequately designed safe and compatible with all conditions encountered during use and in conformance with existing standards and requirements. Contact Panasonic for the latest information.